

## Design and Development of access control management system based on IAP15F2K61S2

Yiwang Wang<sup>1,a\*</sup>, Mengdi Ni<sup>1</sup> and Houchen Shi<sup>1</sup>

<sup>1</sup> School of Electronic & Information Engineering, Suzhou Vocational University, Suzhou 215104, Jiangsu, China.

<sup>a</sup>wyiwang@163.com

\*Corresponding author

**Keywords:** STC MCU, IAP15F2K61S2, Wireless communication technologies, Campus management, System design and realization, Energy saving and environmental protection.

**Abstract.** For the needs of modern access management system, integrated with wireless communication technologies, a novel access control management system based on IAP15F2K61S2(STC MCU) was designed and developed. The system consisted of IAP15F2K61S2, RFID reader module, display module, clock and data storage module, GPRS/GPS modules, solar-powered and other components. The system can read out and identify of RFID card information that access control and other applications, the access control time of RFID card and GPS location information which sent via GPRS SMS contact to set number. In order to make the contacts to grasp the situation of s in the , and the management implementation easy to manage those s access control . According to the outdoor characteristics of the system applications, the innovative design solar-powered circuit for the system. The system has some advantages of functional scalability, wide application range, energy saving convenient and flexible benefits.

### Introduction

Organization of the Text The management of in and out is one of the most important and difficult security and management problem. Use access control systems, which can reduce manual workload and possible errors, achieve automatic recognition of identity, increase the safety factor of the . In the traditional management model, mostly using only a single card and wireless management information systems, and positioning and other functions not available on management, which to some extent affected the ease of use and range of application access control system<sup>[1-3]</sup>.

Through the development of intelligent security access control system that can effectively manage the implementation of the safety and prevention. In the existing security access control system, using wireless communication technologies and other advanced techniques that can improve the level of management.

In this paper, a novel s access control management system based on IAP15F2K61S2 was designed and developed. The system consisted of IAP15F2K61S2, RFID reader module, display module, clock and data storage module, GPRS and GPS modules, solar-powered and other components. The system can read out and identify of RFID card information that access control ,then the access control time of RFID card, GPS location information is sent via GPRS SMS contact to set number. In order to make the contacts to grasp the situation of s in the , and the management implementation easy to manage those s access control . According to the outdoor characteristics of the system applications, the innovative design solar-powered circuit for the system. In outdoor applications system use solar power, which has environmentally friendly energy-saving effect. The designed system will provide new ideas and ways for smart construction and management.

## System Design Scheme

The system design scheme for an access control management system based on RFID/GPS/GPRS technologies as shown in Fig.1, the whole system design scheme consisted of ID(RFID), access control device, GPRS and GPS modules and mobile terminals.

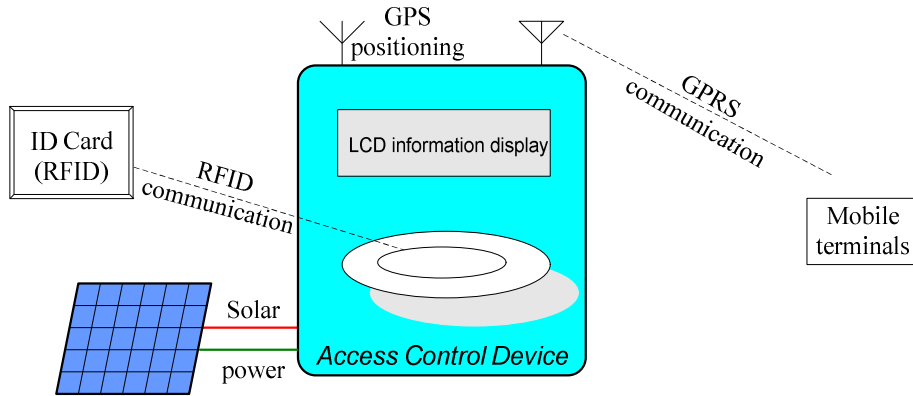

Fig.1 Structure of access control control and management system

In the system scheme, the access control control device receives and collects GPS positioning location data, which easy to use in a different and other applications, comparison to the location data and design of geographic information, then obtain the application orientation of management systems. The ID card is RFID, when the access control of , by carrying out the brushing card management in the device, the access control control device reads the RF card information management,

After the single chip microcomputer in the access control control device identified the RF card information, call the corresponding contact stored contact information from the storage module, call the corresponding stored contact information from the storage module, then via GPRS communication module send out of the information to the appropriate mobile terminals, to facilitate the contacts to grasp s' the situation and pss in/out time of the .

## Hardware Design

The system uses a high-performance single chip microcomputer IAP15F2K61S2 STC as the core control chip, system hardware architecture platform as shown in Fig.2. The single chip microcomputer is the system master control module, the other major modules include an RFID module, GPS module and a GPRS module, display module and so on.

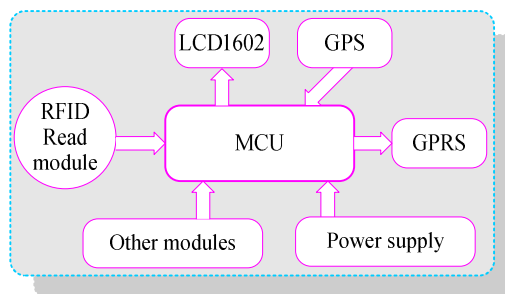

Fig.2 Structure of hardware platform system

**Microcontroller circuit design.** IAP15F2K61S2 is the latest production STC microcontroller with single clock control, has internal integrated precision R/C clock, eliminating an external crystal oscillator and reset circuits, 2 UARTs, 3 CCP / PWM / PCA, 8 high-speed A / D conversion, through an SPI protocol communication with slave devices, the single chip microcomputer minimum system shown in Fig.3.

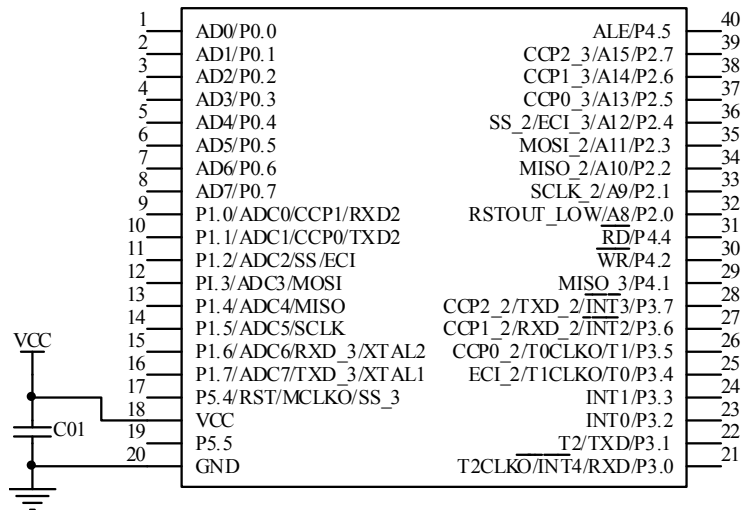

Fig.3 Schematic diagram of MCU smallest system

**GPS Module circuits Design.**GPS module selection NEO-6M, NEO-6M is a high performance GPS positioning module. The module uses U-BLOX NEO-6M module group, the module comes with high performance active dual antenna system. Module via serial port connected external system, baud rate 9600BPS, compatible 5V/3.3V microcontroller system. In this design, the single chip microcomputer IAP15F2K61S2 uses UART (serial port) mode to communicate with NEO-6M GPS module, the GPS module interface circuit connection diagram is shown in Fig.4.

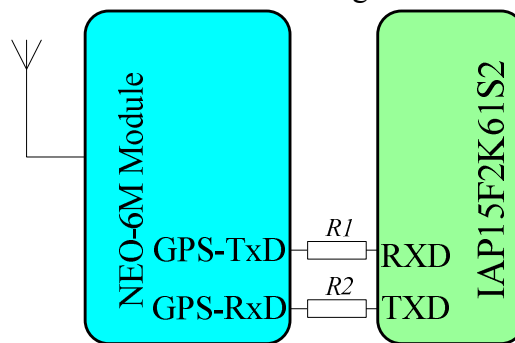

Fig.4 GPS module interface circuit connection diagram

**RFID Module circuits Design.**RFID reader module using the RC522,RC522 is Philips company launch a non-contact low-power read and write chip,it is applied to 13.56MHz contactless communication highly integrated chip card reader. The reader chip series use advanced modulation and demodulation concept completely integrated in all types of passive 13.56MHz contactless read methods and protocols. RC522 supports all IS014443A layer, transmission speeds up to 424kbps, internal transmitter section is not required to increase the active circuit can directly close drive,receiving portion provides a rugged and effective demodulation and decoding circuit,use for receiving IS014443A compatible response signal.Digital processing section provides parity and CRC check detection. Microcontroller IAP15F2K61S2 via SPI bus connected with RC522 module, the connection circuit diagram shown in Fig.5.

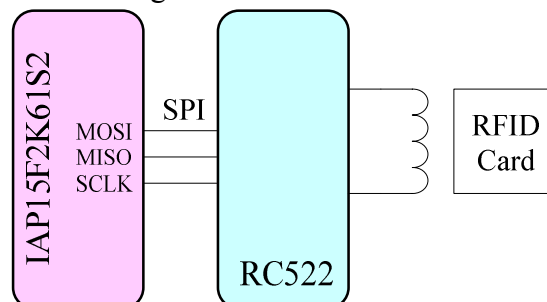

Fig.5 RFID module interface circuit connection diagram

**GPRS Module circuits Design.** GPRS wireless communication module using SIM900A, SIM900A is compact products, which are dual-band GSM / GPRS module. SIM900A uses industry-standard interface, the operating frequency at GSM / GPRS 850/900/1800/1900 MHz, can achieve low-power voice transmission , SMS, data and fax information. It has a stable performance, appearance compact, cost-effective advantages. IAP15F2K61S2 used serial communication interface connected with the GPRS Module. To achieve real-time SMS notification when the s access control .The connection circuit diagram shown in Fig.6.

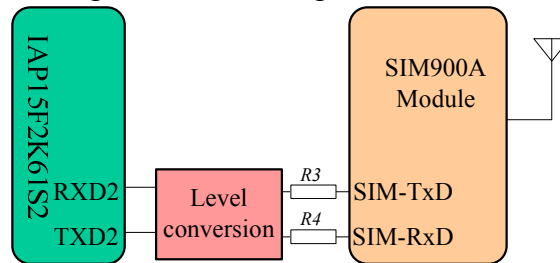

Fig.6 GPRS module interface circuit connection diagram

**Other circuits design.** Other circuit includes a solar power supply circuit, display circuit, wherein the LCD1602D display circuit mainly used for displaying access, GPS information and other content. These circuits are part of the conventional circuit, not described in detail here.

## Software Design

**System software composition.** The software of s access control management system based on RFID/GPS/GPRS technologies includes RF card input processing module, display and other modules, GPS signal input processing module and GSM short message sending module, etc., through its control, security management system can collect GPS data in real time and detect whether has RF card brush into the device. Once the RF card brush into the device, the system will control the GSM module send out location and time information. In order to achieve real-time monitoring of s access control of the dynamic requirements. Entire software components shown in Fig.7.

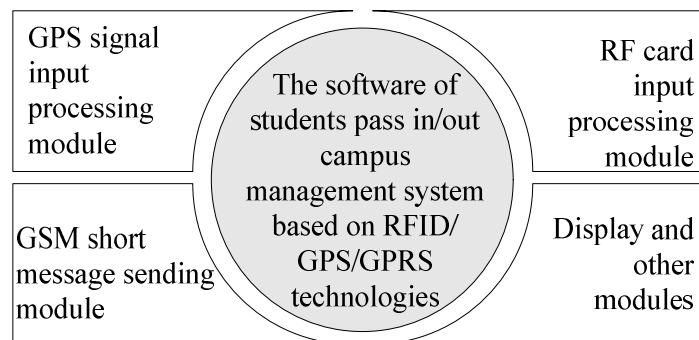

Fig.7 s access control management system software composition

GPS information input processing module is used to process the information of the current position, and the information is sent to the main program, calls the appropriate subroutine for processing by the main program, and then outputs the corresponding operation and display through the display module and control module.

RF card input processing module is used for the input signal by radio card operations and testing requirements transformed to conform to determine the detection module requirements. By the main timer interrupt calls.

GSM SMS module according to single chip microcomputer signal, once the microcontroller sends out signals, the information is sent to the mobile terminal. Main software flow chart shown in Fig. 8.

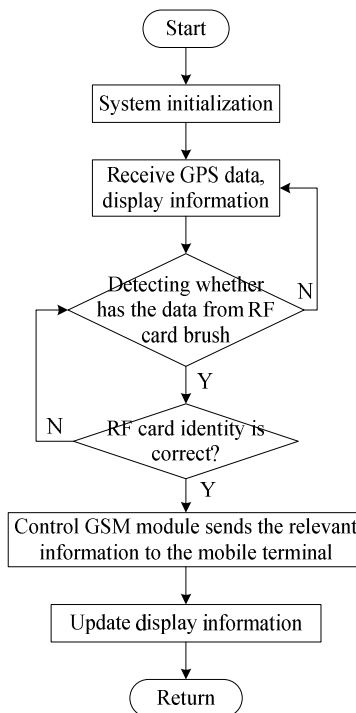

Fig.8 Management system work flow chart diagram

### Prototype system design and implementation and experimental results

A prototype system of s access control management system based on RFID/GPS/GPRS technologies was designed and implementation according to above scheme, prototype shown in Fig.9.

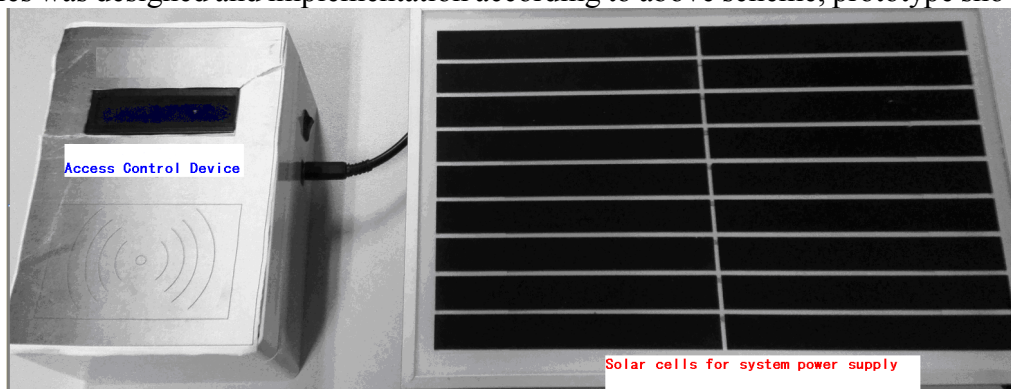

Fig.9 System device prototype

In the prototype testing system, the system first completed location positioning ,then detect whether there RF card, if an SMS message is sent to the corresponding contact number, notify the dynamic information of the s pass in/out to the contact. Some debugging and testing experiments in the prototype system were carried out, The experimental results shown in Fig.10. As can be seen from the debug and test results, the designed system can accurately achieve the functionality required and achieve the requirements of the indicators.



Fig.10 Experimental results

## Summary

Integrated with wireless communication technologies, a novel access control management system management system based on IAP15F2K61S2 was designed and developed. A prototype system was developed and implementation, and the prototype system debugging and testing experimental results show that the designed system can be read out of the ID card access control information, GPS location information and time, then sent these information to contact number via GPRS SMS, so that the contact to grasp the situation of s in the , but also easy to manage and implementation. and the management implementation easy to manage access . The system has advantages of functional scalability, wide application range, convenient and flexible benefits.

## Acknowledgement

This work was supported by the 2014 Senior Talent Culture Project of Suzhou.

## References

- [1] Deng Xiaolei , Li Minzan, Wu Jia, et al. Development of mobile soil moisture monitoring system integrated with GPRS, GPS and ZigBee[J]. Transactions of the Chinese Society of Agricultural Engineering (Transactions of the CSAE), 2012, 28(9): 130-135.
- [2] WEI Qiang.Design of campus building access control and management system based on contactless integrated circuit technology[J]. Computer Engineering and Design, 2014, 29(14): 3771-3775.
- [3]Li Hongyan,Gao Yangdong , Yan Xiaoru. Embedded System of Campus Navigation and Positioning Based on GPS and GPRS[J]. Computer Measurement&Control, 2013,21(12): 3377-3779.
- [4] YAO Zhenqiang, WANG Jian, HU Yongxiang. An Intelligent Supervision System for Hazardous Materials Logistics Based on RFID/GPRS/GPS/GIS[J]. Journal of Highway and Transportation Research and Development, 2013,32(2): 147-152.
- [5] ZHANG Hua Qiang,LI Yu Feng, ZHANG Xiao Yan. The design of heat meter's pre-pay module based on MFRC522[J]. Computer Technology and Its Applications, 2010,36(8): 142-144.(in Chinese with English abstract)
- [6] Information on <http://www.STCMCU.com>
- [7] Information on <http://www.baidu.com>